

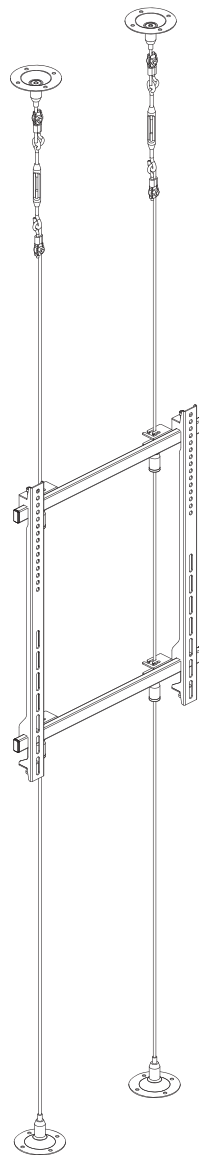



## Istruzioni di montaggio - ref. 032-2003







Supporto schermo a cavo 42" - 75" 3m  
Peso max : 30kg per schermo  
VESA 400x600mm







# Lista



A1	A2	A3	A4
M5X15 	M6X15 	M8X15 	Ø16xØ6.2x1.5 
X4	X4	X4	X4

X1

B1	B2	B3	B4
	6mm 	Ø16xØ6.2x1.5 	Ø6x50 
X2	X8	X8	X8

X2

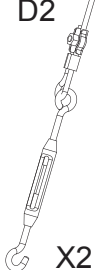
C1	C2	C3	C4	C5	C6
				5mm 	
X1	X4	X4	X4	X1	X4

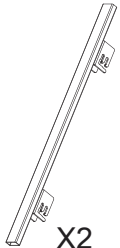
D1	D2	D3	D4	D5
		 3000mm/ 6000mm		
X4	X2	X2	X2	X2

# Installazione

**1**

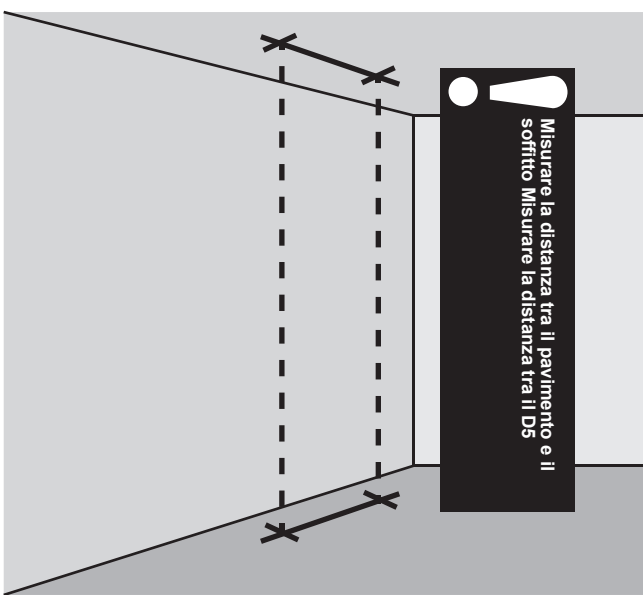

Misurare la distanza tra il pavimento e il soffitto. Misurare la distanza tra il D5

Accertare l'altezza e la larghezza dell'installazione

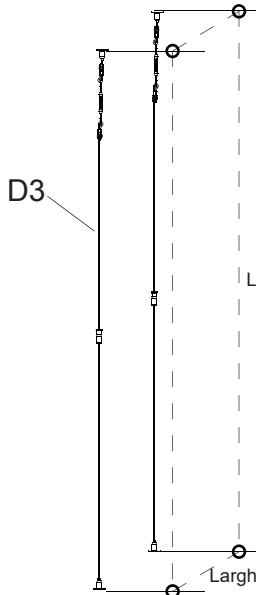

D3

Larghezza (3000mm)

Larghezza / Altezza

**2**

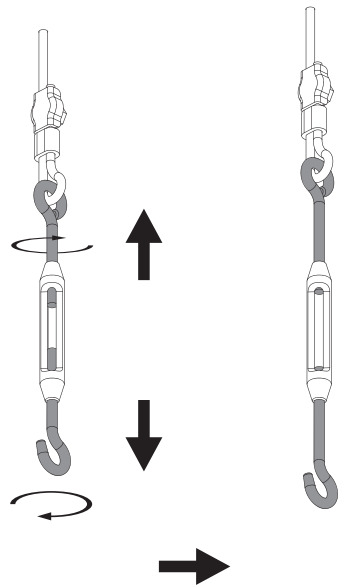

**3**

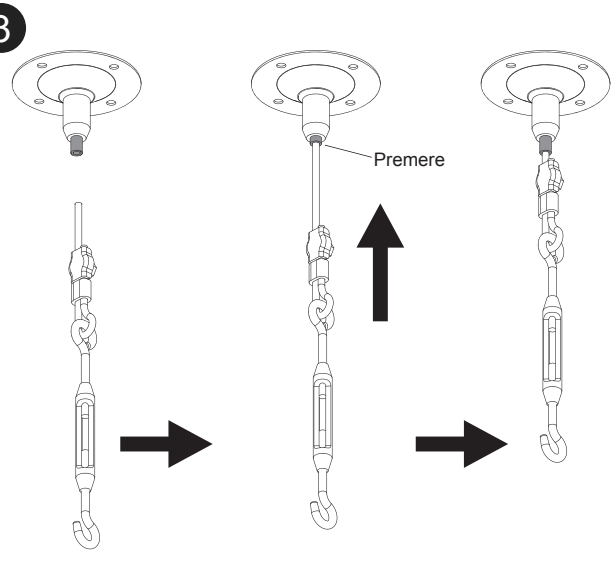

Premere

